

CLIMAGUARD AIR-TO-WATER INDOOR

WCHE01	WCHE04/WCHE06	WCHE14
2968 BTU/Hr.	7506/10577 BTU/Hr.	22861 BTU/Hr.
870 Watts	2200/3100 Watts	6700 Watts

INDUSTRY STANDARDS

UL/cUL Listed; Type 12; File No. SA33866
--

CE
EAC (230V models only)
IP55

APPLICATION

- Industrial process controls
- Industrial robotics controls
- Electronic cabinets in harsh environments
- Conveyor systems

FEATURES

- Capacities ranging from 870 watts to 6700 watts
- Filterless design
- NEMA power cord connection standard
- Copper pipe and aluminum fins heat exchanger core
- Air movers with thermal protection
- Regulating mechanical thermostat set at 35 C (95 F), differential of 4 C (7 F)
- Inside cabinet temperature from 10-50 C (50-122 F)
- Ambient operating temperature range from 10-70 C (50-158 F)
- Solenoid water valve
- UL Listed to save customers time and money with agency approvals
- Recovery of condensation system and condensation discharge pipe
- Requires an available cooled water source

FINISH

- Standard models constructed of rugged steel
- RAL 7035 light-gray, powder-coat polyester paint

Performance Data **WCHE01 Models 870 Watt**

CATALOG NUMBER	WCHE01916002	WCHE01926002
COOLING PERFORMANCE		
Nominal:		
BTU/Hr. @ Δt 25 C	2968	2968
Watts @ Δt 25 C	870	870
Refrigerant	NA	NA
Refrigerant Charge (ounces/grams)	NA	NA
Inside Cabinet Temperature Range:		
Maximum (°F/°C)	122/50	122/50
Minimum (°F/°C)	50/10	50/10
Ambient Operating Temperature Range:		
Maximum (°F/°C)	158/70	158/70
Minimum (°F/°C)	50/10	50/10
Flow at 0 Static Pressure:		
Internal loop 50 Hz (Airflow: CFM / m ³ /hr.)	194/330	194/330
External loop 50 Hz (Waterflow: GPM @ 95 F)	0.66	0.66
Internal loop 60 Hz (Airflow: CFM / m ³ /hr.)	194/330	194/330
External loop 60 Hz (Waterflow: GPM @ 95 F)	0.66	0.66
ELECTRICAL DATA		
Rated Voltage	115	230
Frequency (Hz)	50/60	50/60
Operating Range	+/- 10%	+/- 10%
Max. Power Consumption (W at 50/60 Hz)	28	28
Max. Nominal Current (A at 50/60 Hz)	0.5	0.5
Starting Current (Amps)	0.7	0.7
Agency Approvals	UL/cUL Listed CE	UL/cUL Listed CE EAC
Power Input Description	Cord with NEMA 5-15 plug	Cord with NEMA 6-15 plug
ENCLOSURE PROTECTION		
UL Type	Type 12/IP55	Type 12/IP55
CONTROLLER		
Description	Basic Mechanical Thermostat	
Thermostat Location	Behind front cover, near the fan	
Factory Thermostat Setting (°F/°C)	95/35	95/35
SOUND LEVEL		
At 1.0 Meters	58 dBA	58 dBA
UNIT CONSTRUCTION		
Material	Mild Steel Sheet Metal Standard	
Finish	RAL 7035 light-gray, semi-textured powder-coat paint standard	
UNIT DIMENSIONS		
Height (in./mm)	15.9/404	15.9/404
Width (in./mm)	12.12/308	12.12/308
Depth (in./mm)	4.49/114	4.49/114
Weight (lb./kg)	19.84/9	19.84/9

Performance Curves for WCHE01 Models 870 Watt

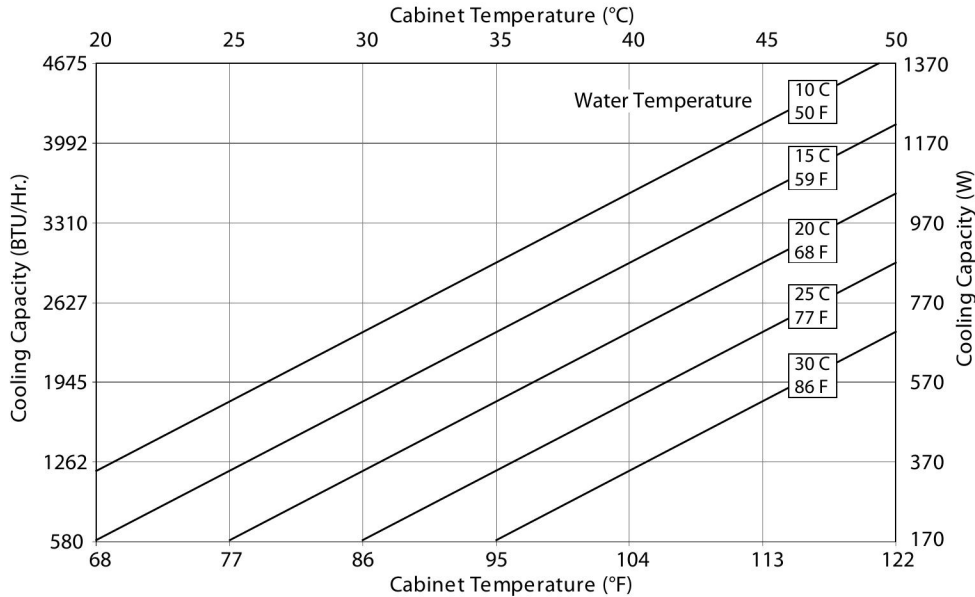

WCHE01 Models 870 Watt

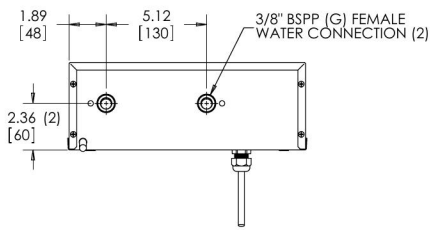
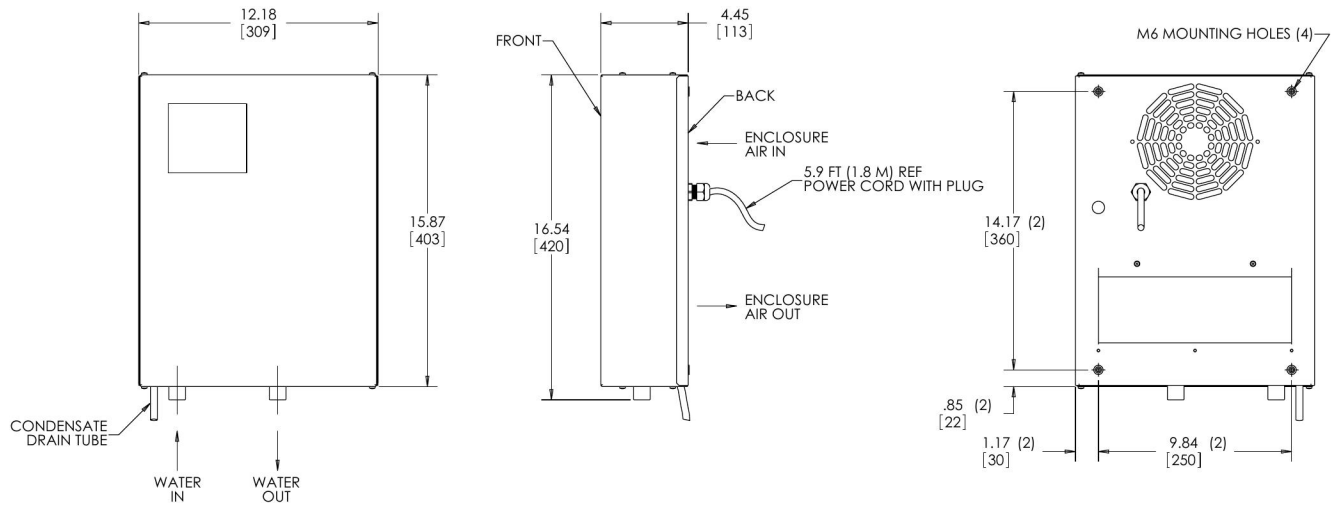

NOTE: "G" to NPT adapting valves are included and shipped with the unit.

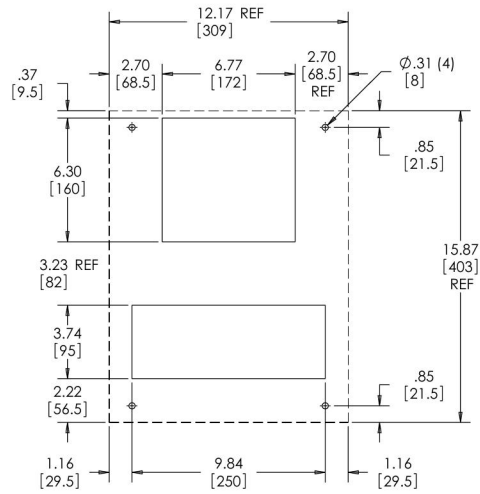

89091145

CUTOUT DIMENSIONS

Visit nVent.com/HOFFMAN to download 2D and 3D CAD drawings into the overall design of your electrical system.

Performance Data **WCHE04 Models 2200 Watt**

CATALOG NUMBER	WCHE04916002	WCHE04926002
COOLING PERFORMANCE		
Nominal:		
BTU/Hr. @ Δt 25 C	7506	7506
Watts @ Δt 25 C	2200	2200
Refrigerant	NA	NA
Refrigerant Charge (ounces/grams)	NA	NA
Inside Cabinet Temperature Range:		
Maximum (°F/°C)	122/50	122/50
Minimum (°F/°C)	50/10	50/10
Ambient Operating Temperature Range:		
Maximum (°F/°C)	158/70	158/70
Minimum (°F/°C)	50/10	50/10
Flow at 0 Static Pressure:		
Internal loop 50 Hz (Airflow: CFM / m ³ /hr.)	339/575	339/575
External loop 50 Hz (Waterflow: GPM @ 95 F)	0.66	0.66
Internal loop 60 Hz (Airflow: CFM / m ³ /hr.)	339/575	339/575
External loop 60 Hz (Waterflow: GPM @ 95 F)	0.66	0.66
ELECTRICAL DATA		
Rated Voltage	115	230
Frequency (Hz)	50/60	50/60
Operating Range	+/- 10%	+/- 10%
Max. Power Consumption (W at 50/60 Hz)	90	90
Max. Nominal Current (A at 50/60 Hz)	0.8	0.8
Starting Current (Amps)	1	1
Agency Approvals	UL/cUL Listed CE	UL/cUL Listed CE EAC
Power Input Description	Cord with NEMA 5-15 plug	Cord with NEMA 6-15 plug
ENCLOSURE PROTECTION		
UL Type	Type 12/IP55	Type 12/IP55
CONTROLLER		
Description	Basic Mechanical Thermostat	
Thermostat Location	Behind front cover, near the fan	
Factory Thermostat Setting (°F/°C)	95/35	95/35
SOUND LEVEL		
At 1.0 Meters	58 dBA	58 dBA
UNIT CONSTRUCTION		
Material	Mild Steel Sheet Metal Standard	
Finish	RAL 7035 light-gray, semi-textured powder-coat paint standard	
UNIT DIMENSIONS		
Height (in./mm)	36.41/925	36.41/925
Width (in./mm)	15.75/400	15.75/400
Depth (in./mm)	8.07/205	8.07/205
Weight (lb./kg)	44.1/20	44.1/20

Performance Curves for WCHE04 Models 2200 Watt

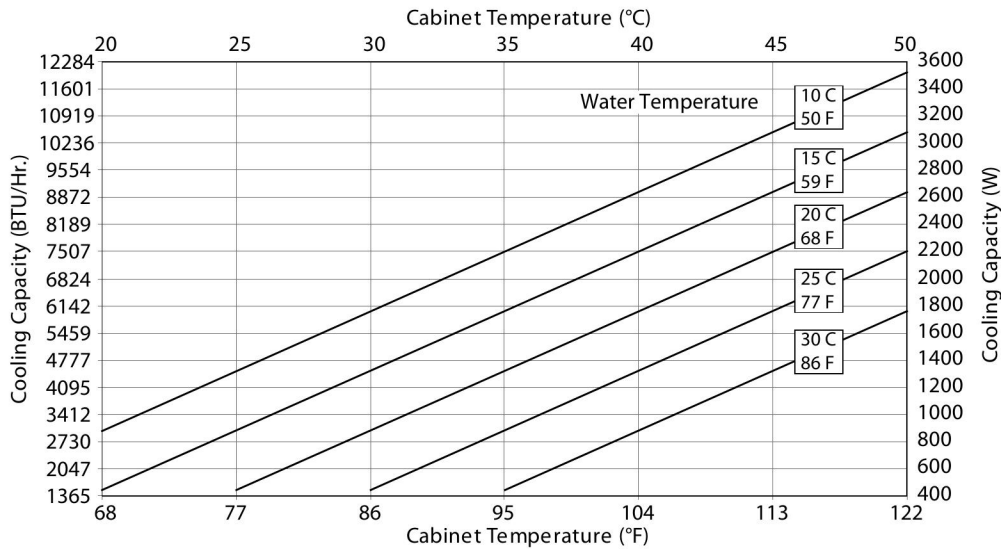

Performance Data **WCHE06 Models 3100 Watt**

CATALOG NUMBER	WCHE06916002	WCHE06926002
COOLING PERFORMANCE		
Nominal:		
BTU/Hr. @ Δt 25 C	10577	10577
Watts @ Δt 25 C	3100	3100
Refrigerant	NA	NA
Refrigerant Charge (ounces/grams)	NA	NA
Inside Cabinet Temperature Range:		
Maximum (°F/°C)	122/50	122/50
Minimum (°F/°C)	50/10	50/10
Ambient Operating Temperature Range:		
Maximum (°F/°C)	158/70	158/70
Minimum (°F/°C)	50/10	50/10
Flow at 0 Static Pressure:		
Internal loop 50 Hz (Airflow: CFM / m ³ /hr.)	507/860	507/860
External loop 50 Hz (Waterflow: GPM @ 95 F)	2.2	2.2
Internal loop 60 Hz (Airflow: CFM / m ³ /hr.)	507/860	507/860
External loop 60 Hz (Waterflow: GPM @ 95 F)	2.2	2.2
ELECTRICAL DATA		
Rated Voltage	115	230
Frequency (Hz)	50/60	50/60
Operating Range	+/- 10%	+/- 10%
Max. Power Consumption (W at 50/60 Hz)	110	115
Max. Nominal Current (A at 50/60 Hz)	2	1
Starting Current (Amps)	2.4	1.2
Agency Approvals	UL/cUL Listed CE	UL/cUL Listed CE EAC
Power Input Description	Cord with NEMA 5-15 plug	Cord with NEMA 6-15 plug
ENCLOSURE PROTECTION		
UL Type	Type 12/IP55	Type 12/IP55
CONTROLLER		
Description	Basic Mechanical Thermostat	
Thermostat Location	Behind front cover, near the fan	
Factory Thermostat Setting (°F/°C)	95/35	95/35
SOUND LEVEL		
At 1.0 Meters	58 dBA	58 dBA
UNIT CONSTRUCTION		
Material	Mild Steel Sheet Metal Standard	
Finish	RAL 7035 light-gray, semi-textured powder-coat paint standard	
UNIT DIMENSIONS		
Height (in./mm)	36.41/925	36.41/925
Width (in./mm)	15.75/400	15.75/400
Depth (in./mm)	8.07/205	8.07/205
Weight (lb./kg)	46.3/21	46.3/21

Performance Curves for WCHE06 Models 3100 Watt

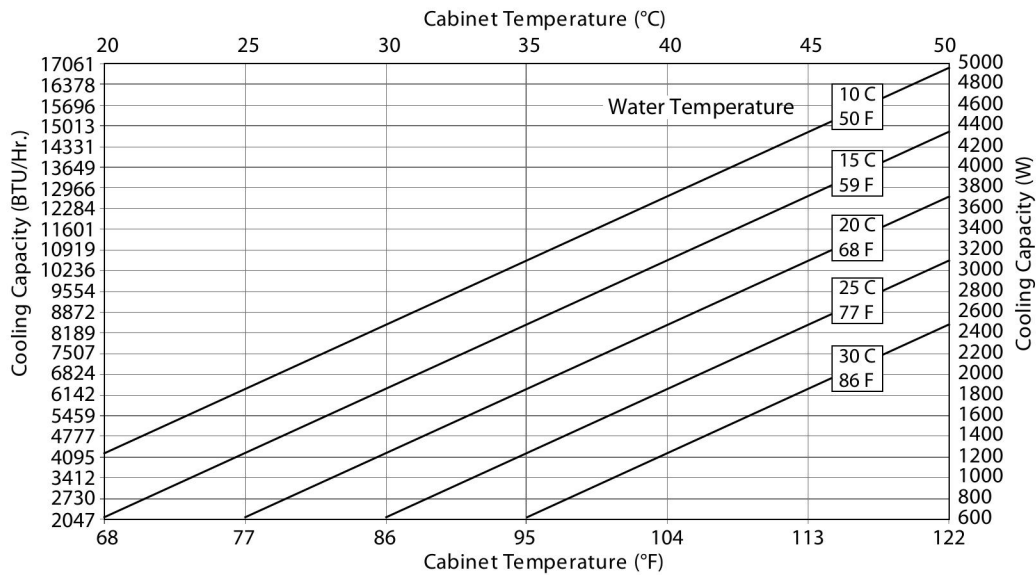

WCHE06 Models 3100 Watt

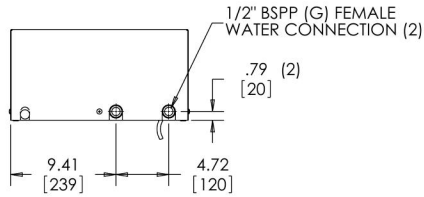
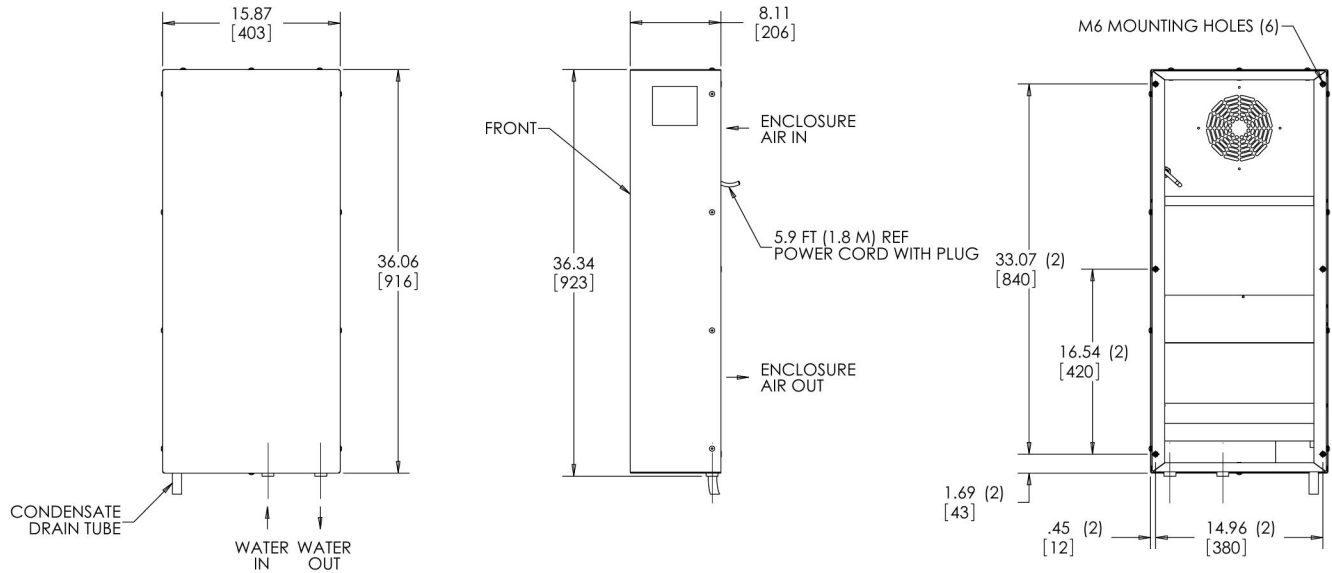

NOTE: "G" to NPT adapting valves are included and shipped with the unit.

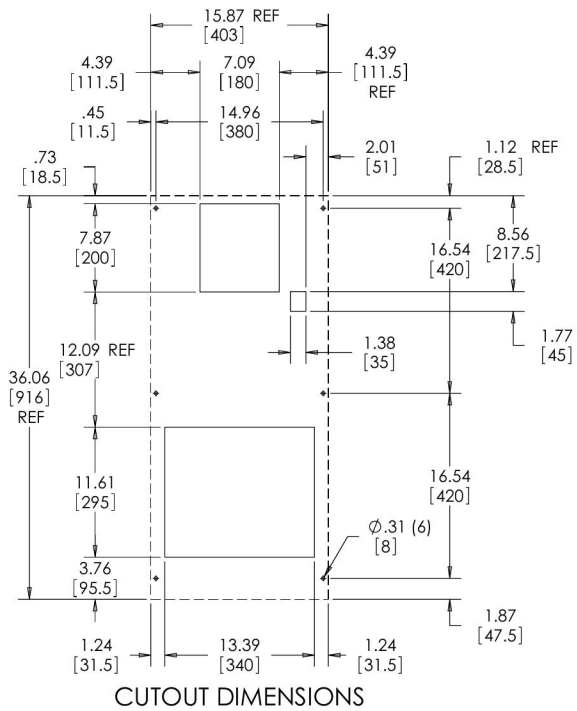

89091147

Visit nVent.com/HOFFMAN to download 2D and 3D CAD drawings into the overall design of your electrical system.

Performance Data **WCHE14 Models 6700 Watt**

CATALOG NUMBER	WCHE14916002	WCHE14926002
COOLING PERFORMANCE		
Nominal:		
BTU/Hr. @ Δt 25 C	22861	22861
Watts @ Δt 25 C	6700	6700
Refrigerant	NA	NA
Refrigerant Charge (ounces/grams)	NA	NA
Inside Cabinet Temperature Range:		
Maximum (°F/°C)	122/50	122/50
Minimum (°F/°C)	50/10	50/10
Ambient Operating Temperature Range:		
Maximum (°F/°C)	158/70	158/70
Minimum (°F/°C)	50/10	50/10
Flow at 0 Static Pressure:		
Internal loop 50 Hz (Airflow: CFM / m ³ /hr.)	855/1450	855/1450
External loop 50 Hz (Waterflow: GPM @ 95 F)	3.78	3.78
Internal loop 60 Hz (Airflow: CFM / m ³ /hr.)	855/1450	855/1450
External loop 60 Hz (Waterflow: GPM @ 95 F)	3.78	3.78
ELECTRICAL DATA		
Rated Voltage	115	230
Frequency (Hz)	50/60	50/60
Operating Range	+/- 10%	+/- 10%
Max. Power Consumption (W at 50/60 Hz)	200	245
Max. Nominal Current (A at 50/60 Hz)	2	1.3
Starting Current (Amps)	2.4	1.4
Agency Approvals	UL/cUL Listed CE	UL/cUL Listed CE EAC
Power Input Description	Cord with NEMA 5-15 plug	Cord with NEMA 6-15 plug
ENCLOSURE PROTECTION		
UL Type	Type 12/IP55	Type 12/IP55
CONTROLLER		
Description	Basic Mechanical Thermostat	
Thermostat Location	Behind front cover, near the fan	
Factory Thermostat Setting (°F/°C)	95/35	95/35
SOUND LEVEL		
At 1.0 Meters	58 dBA	58 dBA
UNIT CONSTRUCTION		
Material	Mild Steel Sheet Metal Standard	
Finish	RAL 7035 light-gray, semi-textured powder-coat paint standard	
UNIT DIMENSIONS		
Height (in./mm)	43.34/1101	43.34/1101
Width (in./mm)	19.72/501	19.72/501
Depth (in./mm)	11.81/300	11.81/300
Weight (lb./kg)	86/39	86/39

Performance Curves for WCHE14 Models 6700 Watt

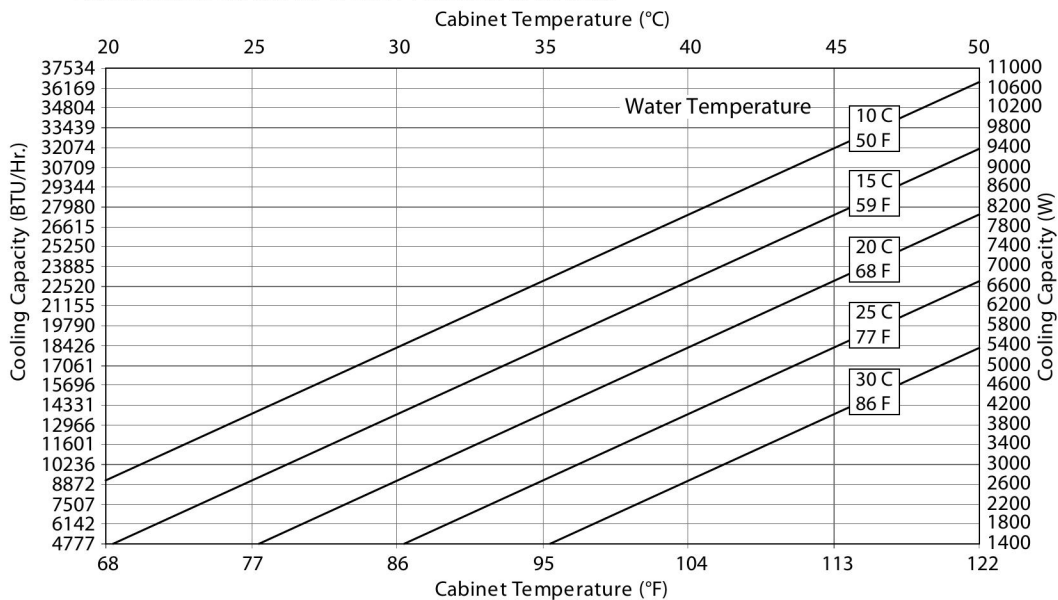

WCHE14 Models 6700 Watt

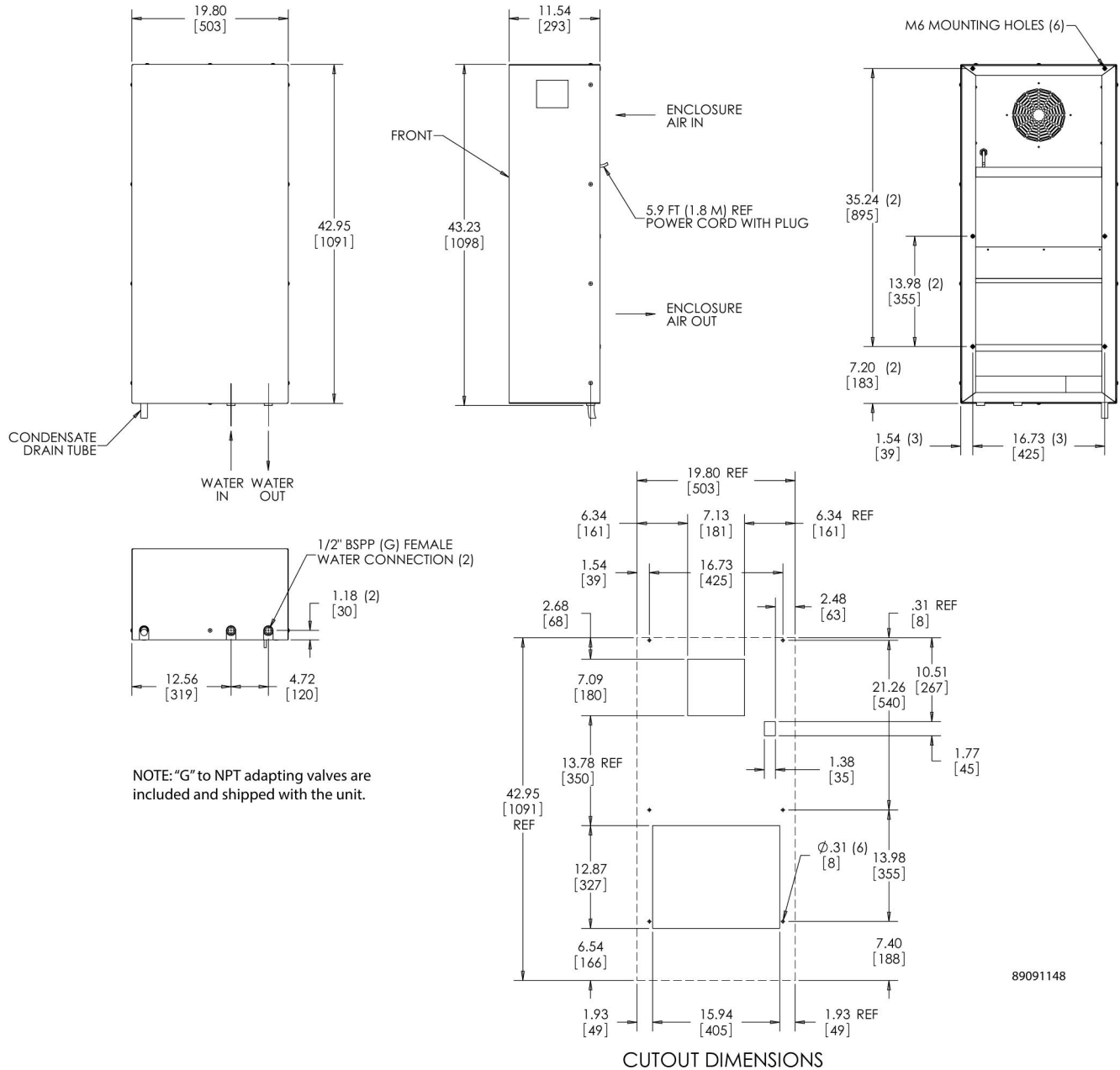

Visit nVent.com/HOFFMAN to download 2D and 3D CAD drawings into the overall design of your electrical system.

Notes

